

ATRIA II 10

REIMAGINING PERFORMANCE SPACES

SPECIFICATION SHEET
TUNABLE WHITE

Housing

Diameter : Ø9.4" | Height : 20.5" | Weight : 30 lbs

Material

Housing : High Pressure Die-Cast Aluminum

Optics : Metal Reflector

Power Input

80W, 110W, 140W, 180W, 220W | 120-277V

Lumen Output

7,000 lm (80W), 9,530 lm (110W), 12,020 lm (140W),
15,155 lm (180W), 18,160 lm (220W)

Dimming

Superior 0-10V : Dims to 1% (2 channel)

1 channel control dimming, 1 channel control CCT

DMX : High resolution dims to 0.1% (2 channel)

(Supports ANSI E1.20 RDM protocol)



Color Quality

CRI 85+

Rated Life

> 100,000 Hours (L70)



Finish

 
Matte Black Matte White





Color Temperature

 ColorFlip™ Tunable White
2700K ↔ 6500K

Optics

  
45° 55° Wide

Mounting

   
Stem Mount Adjustable Cable Wall Mount Yoke Mount

Warranty

5 Year limited warranty

Listing

Versatile and Compact Architectural Cylinder

Engineered for performance spaces, this architectural compact cylinder seamlessly integrates into ceilings, delivering powerful performance with vibrant, color-changing technology that elevates any stage environment.

ColorFlip™ harnesses advanced flip-chip technology, designed in-house, to deliver high-efficacy, flexible, and cost-effective color tuning solutions. This technology ensures robust output and precise color accuracy.

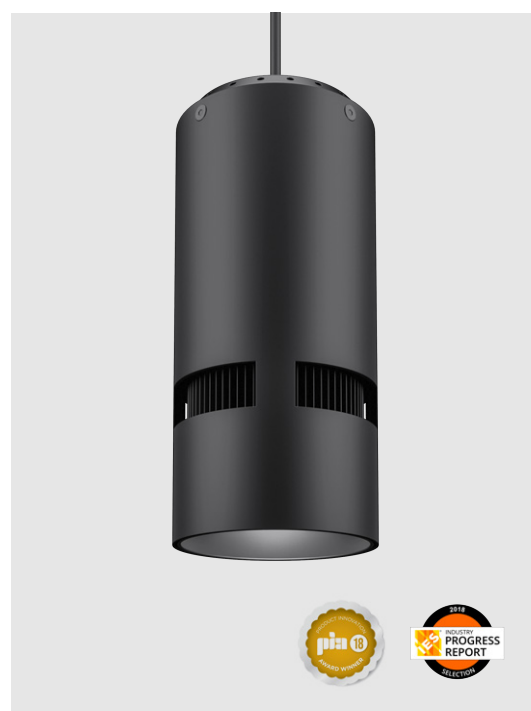

METEOR

meteor-lighting.com

SPECIFICATION

PROJECT NAME

DATE

CATALOG #

QUANTITY

The product configurator function on this page works only with the latest version of Chrome or Adobe Acrobat Reader.

| | | | | |
|-------------------------------------|-------------|---|--|--|
| <input type="text" value="AS1110"/> | MODEL | ATRIA II 10 | | |
| <input type="text"/> | WATTAGE | 80 80W 180 180W | 110 110W 220 220W | 140 140W |
| <input type="text" value="TNW"/> | CCT / CRI | TNW 2700K – 6500K | | |
| <input type="text" value="UNV"/> | VOLTAGE | UNV 120 – 277V | | |
| <input type="text"/> | DIMMING | SPV Superior 0-10V dims to 1% DMXW DMX dims to 0.1% (Hard-wired) | DMX DMX dims to 0.1% (XLR Sockets) | DMXR DMX dims to 0.1% (RJ45 Sockets) |
| <input type="text"/> | BEAM ANGLE | 45 45° | 55 55° | WD¹ Wide |
| <input type="text"/> | FINISH | BLK SilentBlack™, Matte Finish | WHT SilentWhite™, Matte Finish | |
| <input type="text"/> | MOUNTING | ST2 Stem 2ft SAD10 Sloped Adjustable Cable 10ft | ST4 Stem 4ft WLM² Wall Mount | AD10 Adjustable Cable 10ft YKM Yoke Mount |
| <input type="text"/> | ACCESSORIES | SPD³ Surge Protector FCS⁶ Field Cut Stem Adapter Kit | HC⁴ Honeycomb Louver | CT⁵ Conduit Mount |

CLEAR FORM

¹ WD option reduces delivered lumens by ~20%
² WLM is not compatible with DMX, DMXR; connections are hard-wired using three DMX wires
³ Surge protector for up to 10KV. Applicable for unstable mains or facilities using high power machineries
⁴ HC option reduces delivered lumens by ~30%
⁵ CT not compatible with WLM, YKM
⁶ FCS is not compatible with AD10, SAD10, WLM, YKM

TECHNICAL DETAILS

Electrical

- 7,000 lm (80W), 9,530 lm (110W), 12,020 lm (140W)
15,155 lm (180W), 18,160 lm (220W)
- Power Input : Universal (120-277V)
- Operating Temperature : -13°F~112°F
- Surge Protection : Built-in is 4KV
- Remote Emergency Pack : Philips Bodine BSL20B2UEK55C111
- Power Factor Greater than 0.9

LED Features

- ColorFlip™ Tunable White 2700K ↔ 6500K
- CRI 85+
- Long lasting LED luminaire tested under TM21 lumen maintenance L70 @ 100,000 Hrs
- Lumen Maintenance > 0.90 at 60,000 hours

Optics

- Precision molded high transmittance clear PC lens
- Beam Angle : 45°, 55°, WD

Advanced Dimming

- Proprietary VX Driver™ is integrated across all dimming options, delivering video flicker-free performance and full compliance with IEEE 1789.
- Superior 0-10V : Dims to 1% (2 channel)
1 channel control dimming. 1 channel control CCT.
- DMX : High resolution dims to 0.1% (2 channel)
(Supports ANSI E1.20 RDM protocol)

Housing

- Diameter : Ø9.4"
- Height : 20.5"
- Material : High Pressure Die-Cast Aluminum, Metal Reflector
- Weight : 30 lbs

Mounting

- Stem 2ft or 4ft; 45° Swivel Canopy Included
- Adjustable Cable 10ft
- Sloped Adjustable Cable 10ft
- Wall Mount
- Yoke Mount

Warranty

- 5-year limited warranty

Listing

- ETL Damp Location Listed
- CE
- UKCA
- FCC

PERFORMANCE SUMMARY*

| ColorFlip™ | 2700K | 3000K | 3500K | 4000K | 4500K | 5000K | 5700K | 6500K |
|------------------------------|-----------|-----------|-----------|-----------|-----------|-----------|-----------|-----------|
| DMX CCT Signal (%) | 0% | 10% | 25% | 45% | 60% | 70% | 85% | 100% |
| 0-10V CCT Voltage | 0 | 1 | 2.5 | 4.5 | 6 | 7 | 8.5 | 10 |
| 80W | 6,190lm | 6,540lm | 6,895lm | 7,240lm | 7,185lm | 7,120lm | 7,055lm | 7,000lm |
| 110W | 8,430lm | 8,905lm | 9,389lm | 9,865lm | 9,785lm | 9,700lm | 9,610lm | 9,530lm |
| 140W | 10,625lm | 11,225lm | 11,840lm | 12,435lm | 12,340lm | 12,225lm | 12,115lm | 12,020lm |
| 180W | 13,400lm | 14,155lm | 14,925lm | 15,680lm | 15,560lm | 15,415lm | 15,275lm | 15,155lm |
| 220W | 16,055lm | 16,960lm | 17,885lm | 18,790lm | 18,640lm | 18,475lm | 18,305lm | 18,160lm |
| CRI | 85 | 86 | 87 | 88 | 88 | 87 | 86 | 85 |

*Lumen Multiplier 45° baseline 0.95

PERFORMANCE SUMMARY*

| Current Consumption | | |
|---------------------|-------|-------|
| WATTAGE / VOLT | 120V | 277V |
| 80W | 0.73A | 0.32A |
| 110W | 1.01A | 0.44A |
| 140W | 1.28A | 0.56A |
| 180W | 1.65A | 0.71A |
| 220W | 2.02A | 0.87A |

| Emergency Pack Lumen Output Table | |
|-----------------------------------|---------|
| CCT | 6500K |
| LUMEN | 1,750lm |

PHOTOMETRICS

Below is a typical photometric representation of the Atria II 10 fixture. Please download IES files to ensure exact photometric value.

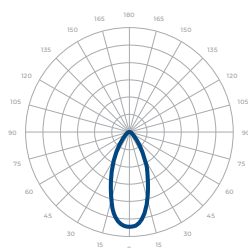

45°

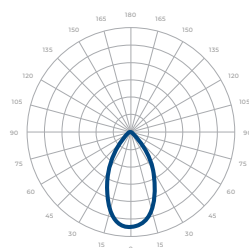

55°

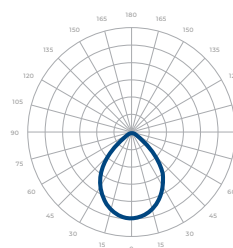

Wide

DMX REQUIREMENTS

The Atria II 10 Tunable White fixture with DMX unit has **two channels** per fixture (1 to control intensity, 1 to control color). When placing an order, please indicate DMX address. (The DMX address will be listed on the back of the fixture). Do not connect more than 32 fixtures per DMX daisy chain.

| Fixture | DMX Address | |
|---------|---------------------------|-------------------------|
| | Intensity Control (ex. X) | Color Control (ex. X+1) |
| #1 | 1 | 2 |
| #2 | 3 | 4 |
| #3 | 5 | 6 |

The fixture can be connected with RJ45 or XLR sockets. DMX cables **are not** included; please refer to compatible DMX cabling list for more information. The final fixture on each daisy chain should be terminated by the use of a DMX terminator purchased from a 3rd party or from Meteor.

| CONNECTION | RJ45 (CAT5e) | 5-PIN XLR |
|------------|-----------------------------------|-----------|
| Common | WHITE/BROWN(PIN7) & BROWN (PIN 8) | PIN 1 |
| Signal - | ORANGE (PIN 2) | PIN 2 |
| Signal + | WHITE/ORANGE (PIN 1) | PIN 3 |
| Spare | - | PIN 4 |
| Spare | - | PIN 5 |

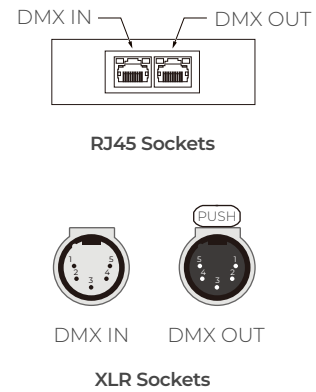

COMPATIBLE DMX CABLING LIST

DMX uses a cable consisting of two twisted pairs plus a shield to carry data. The cable must be specifically impedance matched for the digital DMX signal, meaning that microphone cable or other non-rated cable **must not be used to carry DMX**. Network cable (Cat5, 5e or 6 cable) may be used to carry DMX in an installation; however special consideration must be given to shielding and termination. Under no circumstances should solid core cable like Cat5 be terminated into a screw down connector.

Meteor recommends the use of Belden 9729 or Belden 9841 for DMX installation. Belden 9729/9841 is a shielded twisted pair cable, which allows for a spare pair for 'out and back' type terminations if needed.

DIMENSIONS

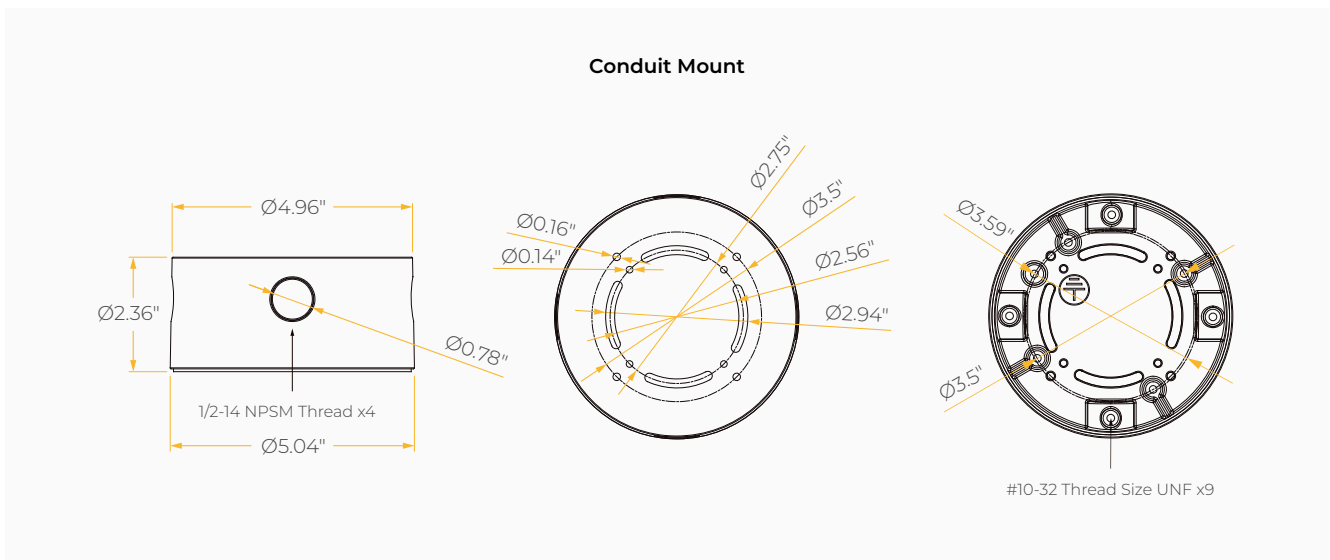
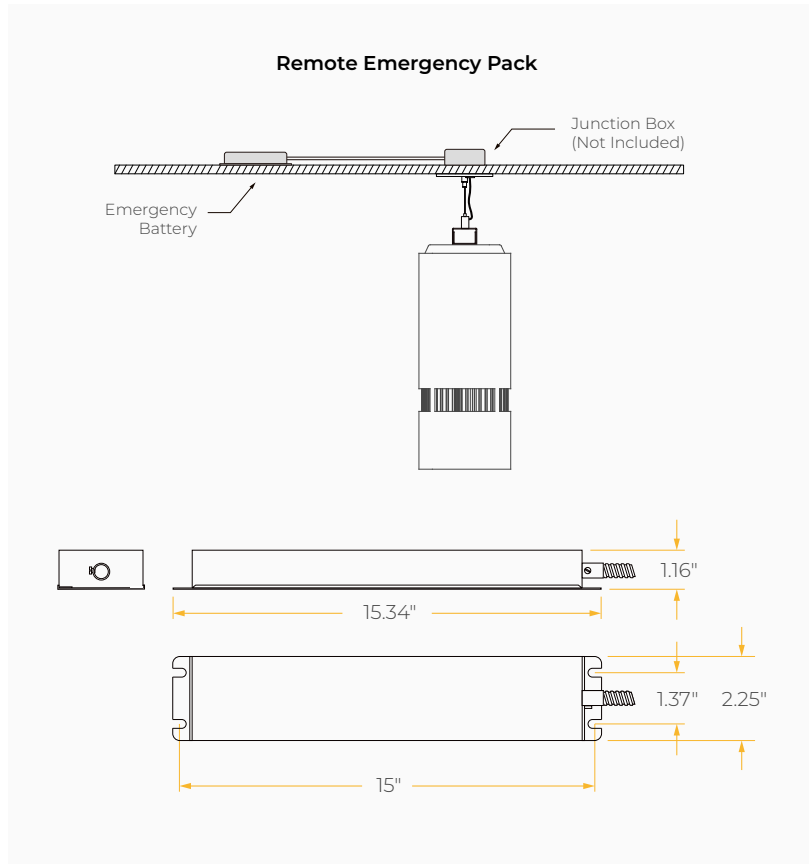
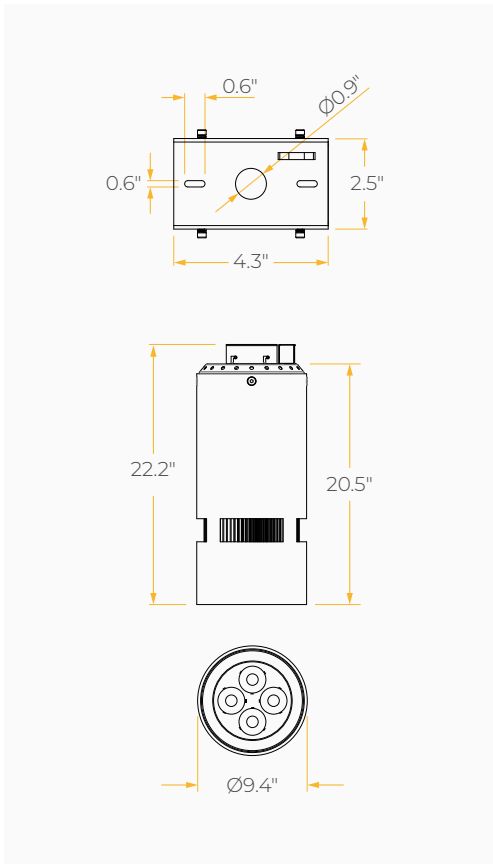

DIMENSIONS

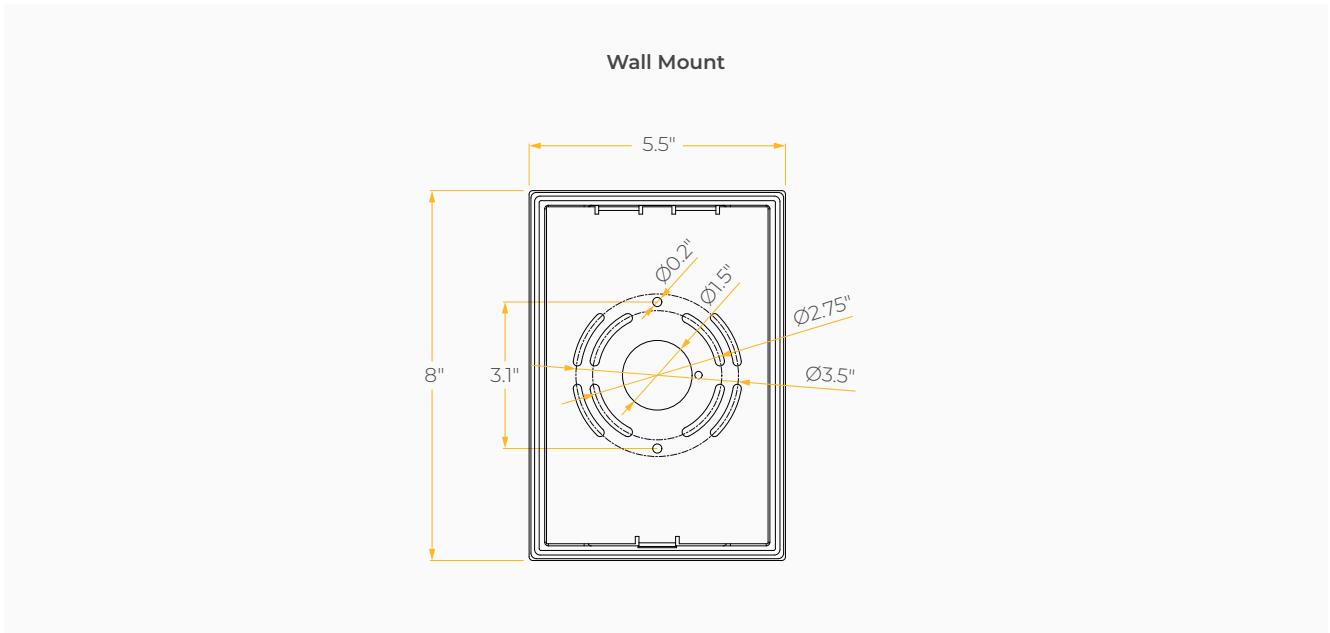

MOUNTING OPTIONS*

*Junction box not included

Stem Mount

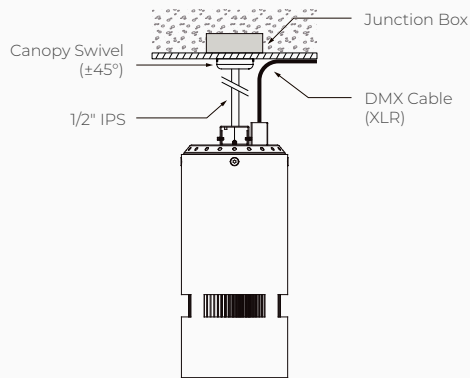

Sloped Adjustable Cable / Adjustable Cable

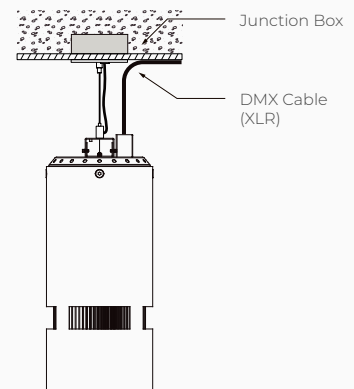

Wall Mount

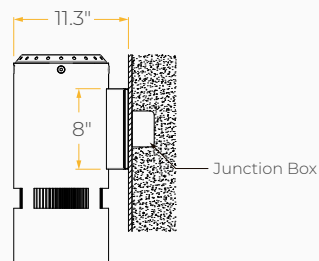

Yoke Mount

